

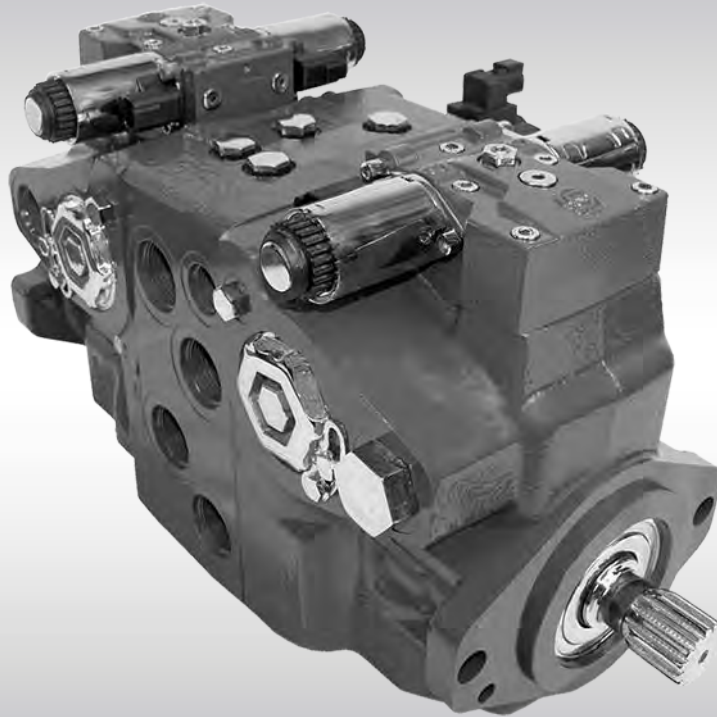

Repair Instructions

Failure Analysis and Parts Evaluation



Revision history*Table of revisions*

Date	Changed	Rev
September 2014	Danfoss layout	BA
Aug 1977	First edition	AA

Contents
Introduction

Overview.....	5
Warranty.....	5
Rework.....	5
General instructions.....	5
Remove the unit.....	5
Keep it clean.....	5
Lubricate moving parts.....	5
Replace all O-rings and gaskets.....	5
Secure the unit.....	6
Safety precautions.....	6

Parts identification

Overview.....	7
---------------	---

Failure analysis concepts and theory

Failure modes.....	8
Lack of lubrication.....	8
Operating at excessive temperature.....	8
Using improper fluid.....	8
Aerated fluid.....	8
Abrasive contaminants.....	8
Overspeeding.....	8
Parts worn or scored from contamination.....	8
Parts scored from water in oil (non-particle contaminants).....	9

Axial piston products parts evaluation

Overview.....	10
Scratches or grooves.....	10
Rework.....	10
Replace.....	10
Piston/slipper assembly.....	11
New slipper.....	11
Particle contamination.....	11
Chemical contamination.....	12
Discoloration/overspeed/lubricity/chemical etching/rolling.....	13
Adhesive wear (smearing or galling).....	14
Discoloration.....	14
Overheating.....	14
Separation.....	15
Slipper retainer.....	16
Discoloration/overspeed.....	16
Broken.....	16
Scoring.....	17
Cylinder block.....	17
Contamination.....	17
Pitting.....	18
Lack of lubrication.....	18
Chemical reaction.....	18
Lack of lubrication.....	19
Ball guides.....	19
Scoring/wear.....	19
Swashplate.....	20
Contamination.....	20
Adhesive wear (smearing, galling or scuffing).....	21
Valve plate.....	21
Contamination.....	21
Cavitation.....	22
Lack of lubrication.....	22
Charge pump assembly.....	23
Contamination.....	23

Contents

Cavitation.....	24
Shaft bearing.....	24
Pitting.....	24
Shafts.....	25
Torsional overload and bending fatigue.....	25
Axial load.....	25
Radial load.....	27
Interference.....	27
Misalignment.....	27
Endcap - bent axis motors.....	28
Block/segment tipping.....	28
Sync shaft - bent axis motors.....	29
Twisted sync shaft.....	29
Twisted sync shaft - wear marks.....	30
Broken rollers.....	30
Damaged sync shaft.....	31
Damaged block raceway.....	31
Bearing plate - bent axis motors.....	32
Contamination.....	32
Piston - bent axis motors.....	32
Scored piston.....	32
Overspeed.....	33
Scoring in block bores.....	34

Gear products parts evaluation

Shafts.....	35
Fretting corrosion.....	35
Misalignment and fatigue.....	35
Overload.....	36
Fatigue and wear.....	38
Negative inlet pressure.....	38
Cavitation - adhesive wear.....	38
Normal cut-in appearance.....	39
Pump body showing normal cut-in.....	39
Aerated fluid.....	39
Aerated oil.....	39
Bronzing.....	40
Side loading.....	41
Adhesive wear caused by side loading.....	41
Large particle contamination.....	42
Gear tooth failure.....	42
Lack of lubricity.....	43
Failure caused by lack of lubricity.....	43
Pressure spiking - overload.....	43
Cover/Housing failure caused by pressure spiking.....	43
Over pressure.....	44
Failure caused by over pressure condition.....	44
Excessive cut-in.....	46
Failure caused by excessive cut-in.....	46
Over temperature.....	46
Failure caused by excessive temperature.....	46

Introduction

Overview

This manual provides information and procedures for the evaluation of components removed from a Danfoss hydraulic product.

Warranty

Performing installation, maintenance, and minor repairs does not affect your warranty. If you suspect malfunction of a unit, remove it from the vehicle and plug all open ports. Take the unit to a Danfoss Global Service Partner (GSP) for repair. Major repairs require disassembly of the unit to expose the internal rotating components. Only an authorized Danfoss Global Service Partner may perform major repairs without voiding the unit's warranty. Danfoss trains our GSPs and certifies their facilities on a regular basis. Refer to www.powersolutions.danfoss.com to locate a Global Service Partner near you.

Rework

For specifications on rework of individual components, refer to *Rework Specifications 520L1033*.

General instructions

Remove the unit



Prior to performing major repairs, remove the product from the vehicle/machine. Chock the wheels on the vehicle or lock the mechanism to inhibit movement. Be aware that hydraulic fluid may be under high pressure and/or hot. Inspect the outside of the pump and fittings for damage. Cap hoses and plug ports after removal to prevent contamination.

Keep it clean



Cleanliness is a primary means of assuring satisfactory product life on either new or repaired units. Clean the outside thoroughly before disassembly. Take care to avoid contamination of the system ports. Cleaning parts using a clean solvent wash and air drying is usually adequate.

As with any precision equipment, keep all parts free of foreign materials and chemicals. Protect all exposed sealing surfaces and open cavities from damage and foreign material. If left unattended, cover the pump with a protective layer of plastic.

Lubricate moving parts



During assembly, coat all moving parts with clean hydraulic oil. This assures that these parts are lubricated during start-up.

Replace all O-rings and gaskets



We recommend you replace that all O-rings, seals, and gaskets during assembly. Lightly lubricate O-rings with clean petroleum jelly prior to assembly. Grease must be soluble in hydraulic fluid.

Introduction

Secure the unit



For major repair, place the unit in a stable position with the shaft pointing downward. It is necessary to secure the unit while removing and torquing the endcap screws.

Safety precautions

Always consider safety precautions before beginning a service procedure. Protect yourself and others from injury. Take the following general precautions whenever servicing a hydraulic system.

Unintended machine movement

 **Warning**

Unintended movement of the machine or mechanism may cause injury to the technician or bystanders. To protect against unintended movement, secure the machine or disable/disconnect the mechanism while servicing. Follow the manufacturers instructions for securing the machine.

Personal safety

 **Warning**

Protect yourself from injury. Use proper safety equipment, including safety glasses, at all times.

Flammable cleaning solvents

 **Warning**

Some cleaning solvents are flammable. To avoid possible fire, do not use cleaning solvents in an area where a source of ignition may be present.

Fluid under pressure

 **Warning**

Escaping hydraulic fluid under pressure can have sufficient force to penetrate your skin causing serious injury and/or infection. This fluid may also be hot enough to cause burns. Use caution when dealing with hydraulic fluid under pressure. Relieve pressure in the system before removing hoses, fittings, gauges, or components. Never use your hand or any other body part to check for leaks in a pressurized line. Seek medical attention immediately if you are cut by hydraulic fluid.

Parts identification

Overview

Shown below are some of the parts which require evaluation. Critical surfaces are finished to close tolerances necessary for proper operation. Non-critical surfaces may have a rough finish, tool marks, etc., and are still acceptable for pump operation.

Parts identification



Failure analysis concepts and theory

Failure modes

This information is presented to assist you in describing your findings and to provide you with our experience and expertise. The information supports the brief statements, such as lack of lubrication, or cavitation, etc. that appear in this manual.

Lack of lubrication

Lack of lubrication describes lack of oil or failure in which the hydraulic film between the surfaces of the moving parts was lost during operation. All adjacent moving surfaces require a lubricating fluid film. If the hydraulic fluid film is lost, the components have metal to metal contact which causes **adhesive wear** (smearing or galling) of the mating parts. The degree of **adhesive wear** (smearing/galling) varies, depending on how long the unit ran without the fluid film, as well as the severity of the outside influence which destroyed the fluid film.

Following are some conditions which can cause a loss of the fluid film creating this failure:

Operating at excessive temperature

The viscosity of fluids decreases as the temperature increases. In order to ensure a stable hydraulic film between rotating surfaces, the fluid must maintain a minimum viscosity at all times. If the transmission operates at excessive temperature, viscosity loss may cause an adhesive wear (smearing/galling) condition on the running surface. Refer to the temperature and viscosity specifications in the Technical manual for your particular product.

Using improper fluid

Certain hydraulic fluids have characteristics that are not compatible with the materials and operating conditions of our products. If the fluid does not have adequate lubricating and load carrying characteristics, damage to running surfaces will occur.

Please see *Hydraulic Fluids and Lubricants Technical Information*, **520L0463**, for more information. Refer to *Experience with Biodegradable Hydraulic Fluids Technical Information*, **520L0465**, for information regarding biodegradable fluids.

Aerated fluid

If air or foam are present in the fluid, the air replaces the hydraulic fluid film. The air does not provide adequate bearing support for the running surfaces.

Abrasive contaminants

Abrasive contaminants destroy the hydraulic fluid film. Contaminants can also directly damage surfaces inside the unit. Refer to *Design Guidelines for Hydraulic Fluid Cleanliness* **520L0467**.

Overspeeding

When a pump or motor is run at speeds above ratings, certain components separate and cause high unit loading on the bearing plate and slippers. The initial distress appears as rolling on the outer foot of the bearing plate and on the outer edge of the slipper face. If the unit is subjected to repeated overspeeding conditions, the fluid film will be lost between the rotating surfaces resulting in adhesive wear (smearing).

Parts worn or scored from contamination

This condition is caused by particles of abrasive material in the hydraulic fluid. As these abrasive particles pass through the unit they act as tiny milling cutters, cutting grooves in the surface of bearing materials.

Damage from abrasive particles occurs during operation. The particles that cause the wear are flushed out of the pump into the reservoir. This makes it difficult to determine what specific type of particles

Failure analysis concepts and theory

passed through the unit. Usually we can only inspect the components and the damage from the abrasive particles.

Stereographic analysis of residue in the reservoir can reveal detailed information about the type of abrasive particles in the system.

To prevent this type of failure, always clean all the lines prior to installation and prevent abrasive material from entering the units while installing. Always fill the reservoir with filtered fluid.

Install the proper filter element and ensure the by-pass valve is closed. Also check the element to assure it is not broken or passing contaminants at seams between the element and the filter ends.

Parts scored from water in oil (non-particle contaminants)

This failure occurs when water or other fluid contaminants exist in the hydraulic fluid. Water and/or fluid contaminants usually react with additives in the fluid causing undesirable chemical changes in the fluid. The chemicals react with yellow metal surfaces resulting in an etching. The etching removes material from these surfaces causing high pressure leak paths, eventually causing the unit to become inoperative.

Axial piston products parts evaluation

Overview

The following pages contain guidelines (both written and visual) for determining when to replace components. In addition, we provide information for determining the probable cause of failure by examining the condition of running surfaces.

Although it is possible to reuse parts that do not show damage, for best results when rebuilding a pump, replace all parts that contain bearing surfaces such as valve plates and piston slippers.

After removing components, clean them with an appropriate solvent and air dry before inspection.

Scratches or grooves

When slippers, valve plates, or bearing plates have circumferential scratches or grooves on the running surface, it indicates foreign material in the hydraulic oil. Flush the system and fill with new hydraulic fluid.

If upon inspection of the surfaces, you observe circumferential scratches that you can remove with a minimum amount of polishing or lapping, rework and reuse these parts.

When you can detect scratches or grooves with a fingernail or lead pencil, replace the part or assembly.

Rework

Polish or lap parts using 4/0 grit abrasive on a flat lapping table. Polish parts using polishing solvent or equivalent. Do not dry-polish parts. For information regarding rework of individual components, refer to *Rework Specifications, 520L1033*.

Replace

Replace all parts that are noted as discard or replace in the repair instructions. These parts are not designed for reuse. When rebuilding a pump, non-replaceable parts are available individually or in a complete overhaul kit.

Axial piston products parts evaluation**Piston/slipper assembly****New slipper**

New slipper has no scratches or discoloration. Edges show original chamfer.

New slipper face



F101 690

Particle contamination

Slipper is scratched indicating contaminants suspended in the hydraulic fluid.

When you can detect scratches or grooves with a fingernail or lead pencil, replace piston/slipper set or entire rotating kit. Replace piston/slipper if slipper does not rotate freely on piston in all directions. Flush system and replace hydraulic fluid.

Particle contamination



F101 646

Axial piston products parts evaluation

Particle contamination



F101 645

Particle contamination



F101 647

Chemical contamination

Slipper is etched, indicating chemical contaminants suspended in the hydraulic fluid.

Replace piston/slipper assemblies. Check other components for similar contamination. Flush system and replace hydraulic fluid.

Axial piston products parts evaluation

Chemical contamination

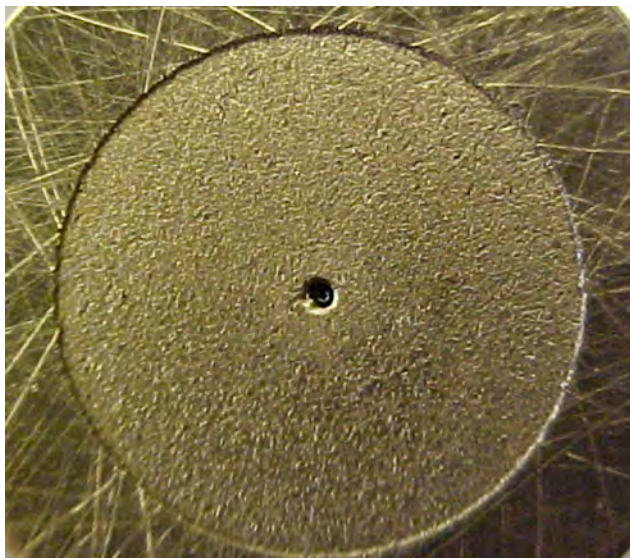

F101 711

[For information on reworking the slippers, refer to *Axial Piston Products Rework Specifications, 520L1033.*](#)

Discoloration/overspeed/lubricity/chemical etching/rolling

Slipper shows discoloration and etching from chemical contamination. This slipper also shows rolling from overspeeding or low charge/high case pressure.

Discoloration



F101 649

Axial piston products parts evaluation

Adhesive wear (smearing or galling)

Slipper face shows adhesive wear caused by lack of lubrication. This indicates insufficient lubrication or improper fluid.

Adhesive wear

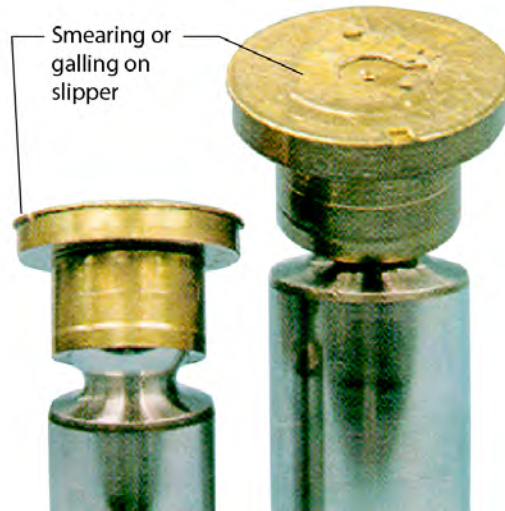

F101 649

Discoloration

Piston body is discolored from system overheating or lack of lubrication. Replace rotating group.

Lack of lubrication



F101 651

Overheating

Discoloration (dark bands) is caused by an overheated system. Oil cooling system failed to properly cool the oil.

Axial piston products parts evaluation

Overheating- Series 15 shown



F101 695

Separation

Adhesion between the piston and cylinder block may result in piston stick and cause separation. Overspeeding, contamination, lack of lubrication, low loop pressure, inefficient inlet conditions, in conjunction with high case pressure may cause separation. Separation also results in slipper retainer scoring or breakage, and piston scoring (see following pages for examples).

Separation



F101 648

Axial piston products parts evaluation**Slipper retainer****Discoloration/overspeed**

This slipper retainer shows discoloration due to overheating caused by overspeeding the pump or running it when it was low on fluid.

Discoloration

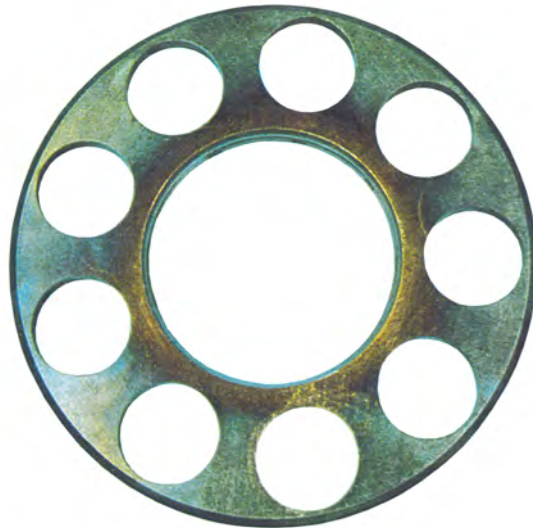

F101 654

Broken

Broken slipper retainer: this is caused by overspeeding. It also indicates the possibility of slipper separation. Check piston/slipper endplay.

Broken



Axial piston products parts evaluation

F101 656

Scoring

The slipper has scored the retainer causing a grooved wear pattern. Particle contamination in the system causes scoring. It also indicates the possibility of slipper separation. Check piston/slipper endplay.

Scored

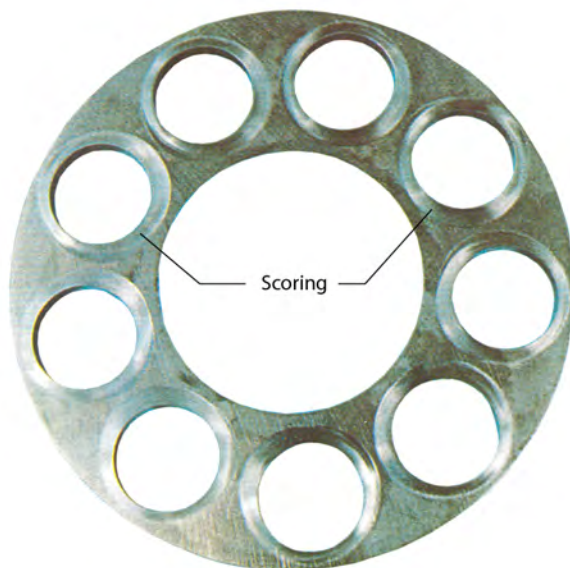

F101 655

Cylinder block

If porting end of cylinder block shows damage, replace it.

For information on reworking the cylinder block, refer to *Axial Piston Products Rework Specifications*, **520L1033**.

Contamination

Cylinder block port face is scratched. When you can detect scratches or grooves with a fingernail or lead pencil, replace the part. Flush system and replace hydraulic fluid.

Axial piston products parts evaluation

Contamination

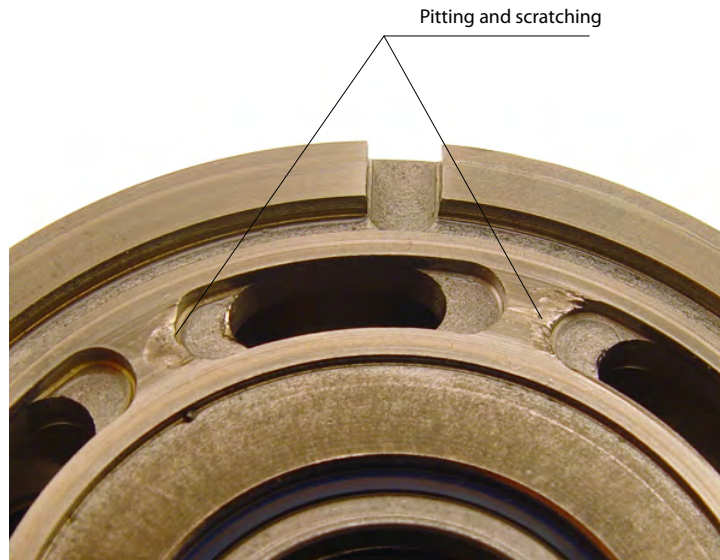

F101 657

Pitting

Pitting on the porting face is due to; overspeed, low charge pressure, cavitation, or aereated fluids.

Lack of lubrication

Cylinder block is damaged due to lack of lubrication. Replace piston assembly and adjoining parts.

Lack of lubrication - Series 90 shown



F101 658

Chemical reaction

Water or chemicals in the hydraulic fluid react and cause damage to yellow metals. Replace piston assembly and any other damaged parts. Flush system and replace hydraulic fluid.

Axial piston products parts evaluation

Chemical reaction - Series 90 shown

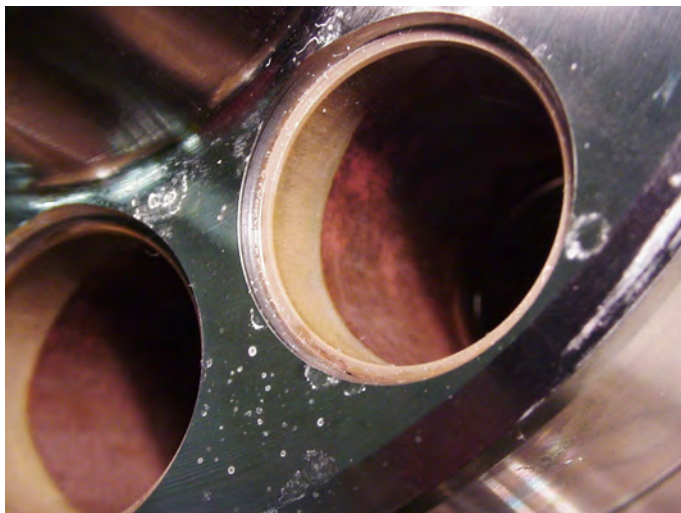

F101 660

Lack of lubrication

Lack of Lubrication can cause piston scoring and slipper separation. Check pistons and piston/slipper end play. Replace cylinder block.

Lack of lubrication - Series 42 shown



F101 659

Ball guides**Scoring/wear**

Ball guide shows scoring and wear caused by particle contamination. Wear around lubrication holes is caused by lack of lubrication or particle contamination.

Axial piston products parts evaluation

Wear - Series 20 shown



Scoring - Series 20 shown



P101661

Swashplate

For information on reworking the swashplate, refer to *Axial Piston Products Rework Specifications, 520L1033*.

Contamination

Swashplate scratching indicates contaminants suspended in the hydraulic fluid. When you can detect scratches or grooves with a fingernail or lead pencil, replace the part. Check piston/slippers for similar damage. Flush system and replace hydraulic fluid.

Contamination - Medium duty swashplate



Contamination

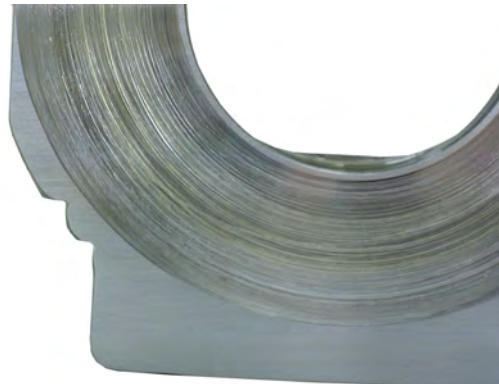

P101663

Axial piston products parts evaluation**Adhesive wear (smearing, galling or scuffing)**

Swashplate is smeared or galled. Bronze material is embedded into the swashplate. Lack of lubrication as a result of insufficient or improper fluid causes this condition.

Adhesive wear - Thrust plate shown

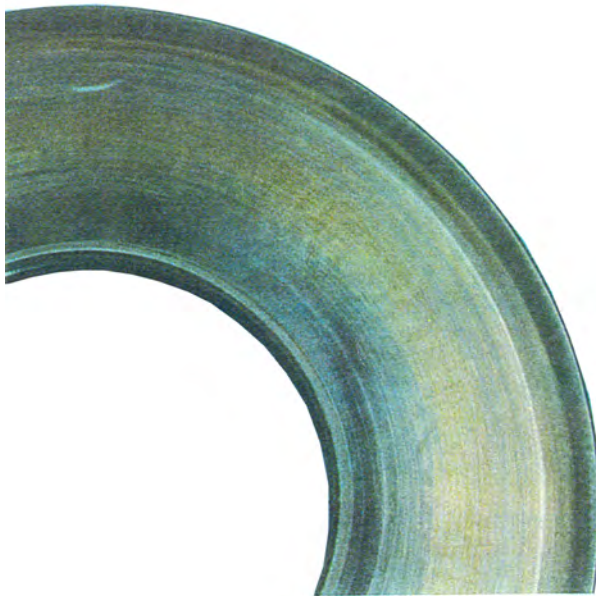

F101 665

Valve plate

For information on reworking the valve plate, refer to *Axial Piston Products Rework Specifications*, **520L1033**.

Contamination

Valve plate is scratched indicating contaminants suspended in the hydraulic fluid. When you can detect scratches or grooves with a fingernail or lead pencil, replace the part. Flush system and replace hydraulic fluid prior to operation.

Axial piston products parts evaluation

Contamination



Contamination

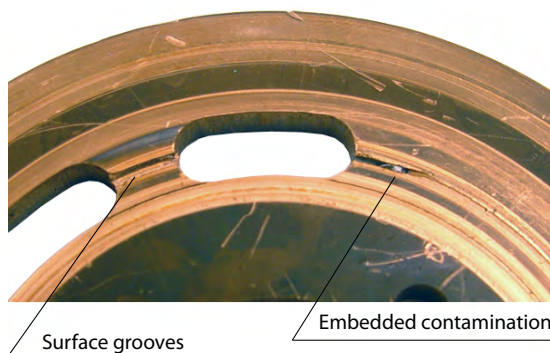

P101670

Cavitation

Valve plate shows cavitation caused by overspeeding, or improper loop pressure conditions and areated oil. Replace valve plate. Check adjoining parts for similar damage.

Cavitation



F101 671

Lack of lubrication

Valve plate shows adhesive wear (smearing) due to lack of lubrication. Replace valve plate. Check adjoining parts for similar damage.

Axial piston products parts evaluation

Lack of lubrication

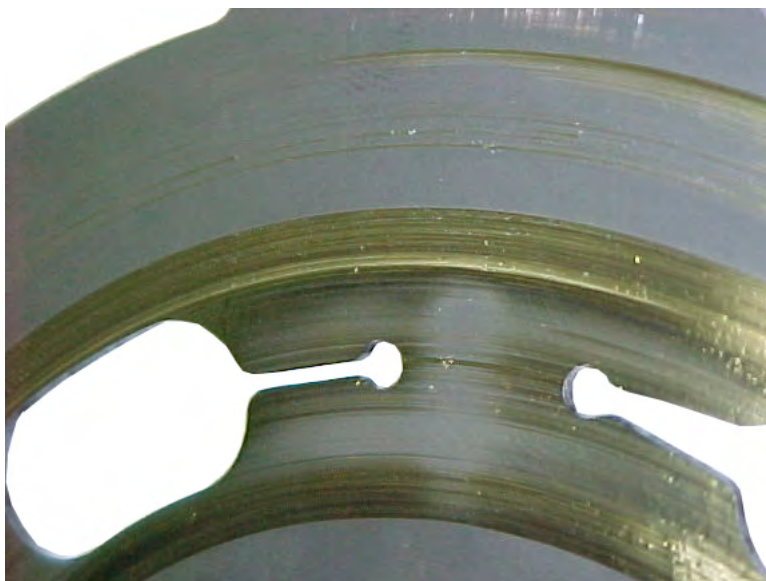

F101 673

Charge pump assembly

Contamination

Charge pump plate is scratched indicating contaminants suspended in the hydraulic fluid. When you can detect scratches or grooves with a fingernail or lead pencil, replace the part. Flush system and replace hydraulic fluid.

New geroter



Particle contamination

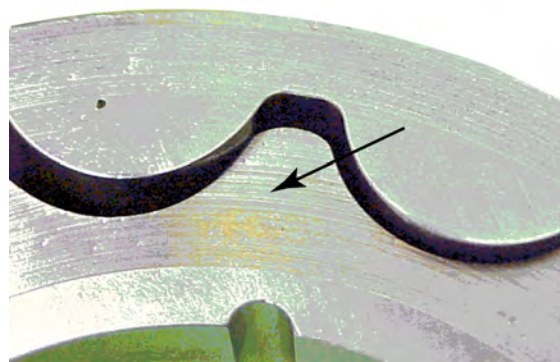

P101675

Axial piston products parts evaluation

Particle contamination

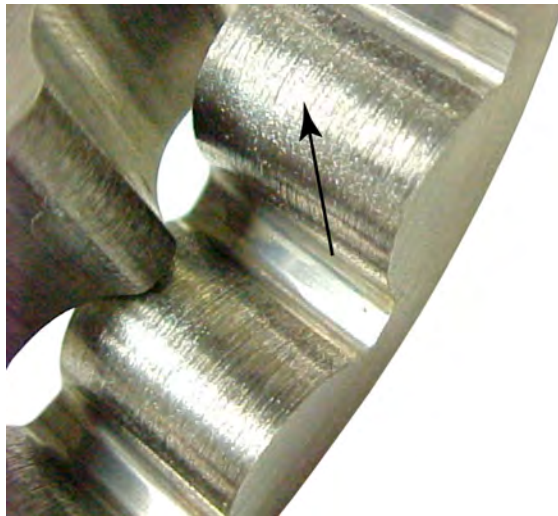

F101 674

Cavitation

Charge pump shows cavitation caused by overspeeding, high inlet vacuum, or improper inlet pressure. Replace charge pump. Check adjoining parts for similar damage.

Cavitation



F101 677

Shaft bearing

Pitting

Bearing race is pitted due to contamination or overload condition.

Axial piston products parts evaluation

Pitting

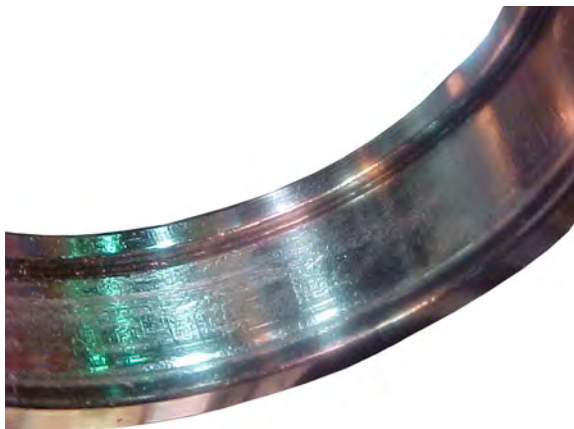

F101 679

Shafts**Torsional overload and bending fatigue**

Shaft failure from torsional load caused by overloading pump pressure or excessive side loading. Replace shaft. Determine and correct cause of excessive torsional load.

Torsional load



F101 680

Axial load

Shaft shows damage from axial load caused by improper fit of pump to prime mover. Check adjoining parts for similar damage. Replace shaft. Ensure proper fit when bolting pump to prime mover. Flush system and replace hydraulic fluid prior to operation.

Axial piston products parts evaluation

Axial load

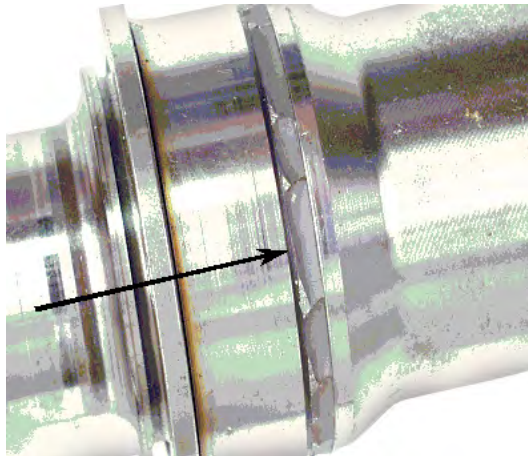

F101 682

Bearing assembly received axial loading which pushed the shaft towards the rear of the pump. The bearing retaining ring has failed and the front shaft bearings is damaged.

Axial load - Series 90 shown



F101 696

Axial load - Series 90 shown



F101 697

Axial piston products parts evaluation

Radial load

Shaft failure from excessive radial load. Replace shaft. Ensure proper alignment with mating component when reinstalling pump.

Radial load

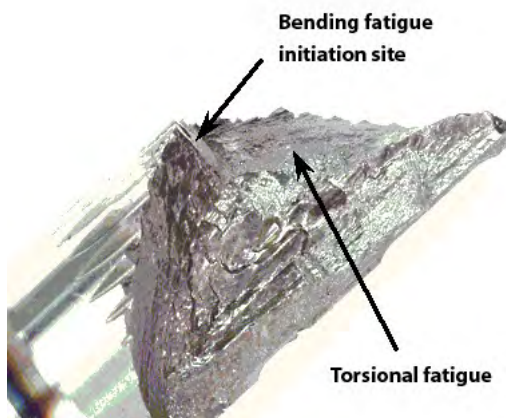

F101 683

Interference

Photo shows interference marks caused by contamination between shaft and mating component. Interference can cause bearing failure or shaft failure.

Interference



F101 684

Misalignment

Photo shows shaft misalignment. Shaft is not completely mated with mating component. Replace shaft. Reinstall pump ensuring proper shaft alignment.

Axial piston products parts evaluation

Misalignment

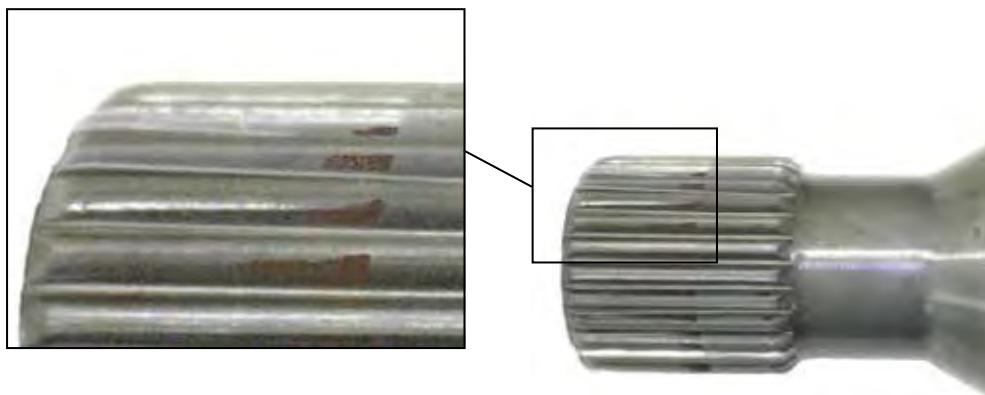

F101 685

Misalignment (bending)

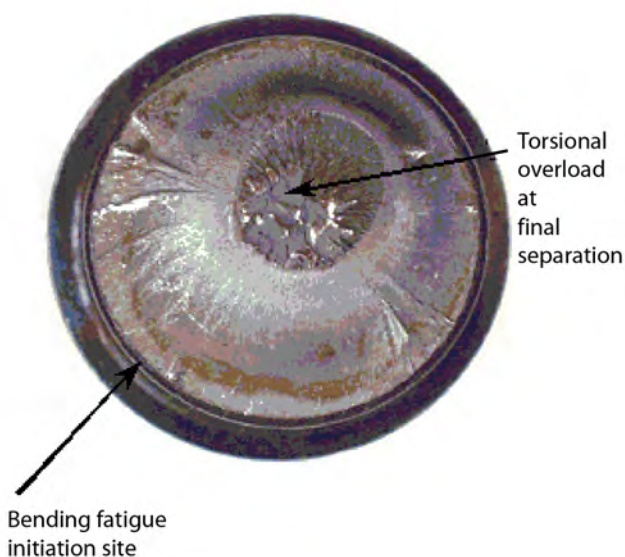

F101681

Endcap - bent axis motors

Block/segment tipping

A symptom of block/segment tipping is a line/lines cut into the end cap by the edge of the valve segment when it tips up. Block/segment tipping can be caused by overspeeding.

A twisted synchronizing shaft can also cause the block/segment to tip up, away from the end cap

Axial piston products parts evaluation

Block/segment tipping - Series 51 shown



F101 698

Sync shaft - bent axis motors**Twisted sync shaft**

Twisting of the synchronizing shaft can occur when a sudden rotational shock overload is induced through the motor output shaft. During rapid loading, twisting is caused by the inertial force of the cylinder block against the synchronizing shaft.

Twisted sync shaft - Series 51 shown



F101 699

A twisted synchronizing shaft causes the timing between the block and pistons to be off enough to cause the block and valve segment to tip up away from the end cap.

Axial piston products parts evaluation

Twisted sync shaft - Series 51 shown



F101 700

Twisted sync shaft - wear marks

A twisted synchronizing shaft can also cause the block/segment to tip up away from the end cap. Wear marks are caused by piston stems rubbing against the edge of the block bores.

Wear marks on piston stems - Series 51



F101 701

Broken rollers

Synchronizing shaft rollers, broken after coming off the sync shaft. The rollers come off when the block tips from overspeeding. The block tips to a bigger angle with the synchronizing shaft and the rollers come out of the raceways in the block. The centrifugal forces of the block turning at excess speed makes it tip. When the block tips it causes the valve segment to tip away from the end cap.

Axial piston products parts evaluation

Broken rollers - Series 51 shown



F101 702

Damaged sync shaft

The synchronizing shaft is damaged after a roller or rollers come off. The end of the leg hits against the roller raceway in the block.

Damaged sync shaft - Series 51 shown



F101 703

Damaged block raceway

This damage to a block raceway for a synchronizing shaft roller, is caused when a roller starts to come off the synchronizing shaft leg, then comes down on the edge of the raceway. The rollers come off the sync shaft legs when the block/segment tips at a bigger angle away from the sync shaft.

Axial piston products parts evaluation

Damaged block raceway - Series 51 shown

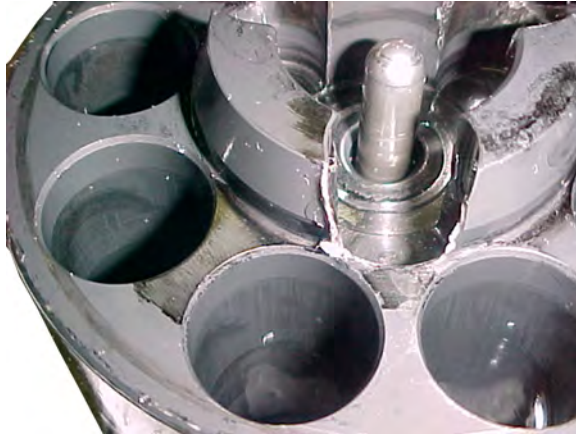

F101 704

Bearing plate - bent axis motors**Contamination**

If a piece of piston ring gets into the system loop, it can cause severe damage. The pump valve plate and block face may also be damaged.

Contamination - Series 51 shown

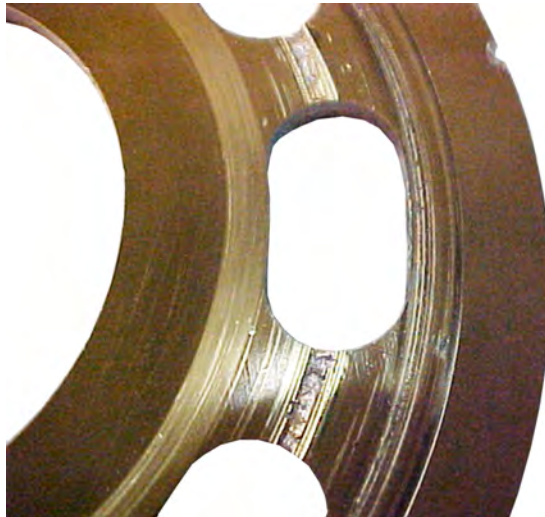

F101 705

Piston - bent axis motors**Scored piston**

Scoring on pistons is caused by loss of lubrication. Loss of lubrication can be caused by low viscosity from over heating or thin oil, improper oil (poor lubricating qualities), or overspeeding. The piston moves so fast back and forth in its bore that it loses its oil film. When the piston land wears down enough it allows the ring to come out of its groove and break. The pieces of the ring usually end up in the motor case or in the drain line. Sometimes pieces go into the system loop and cause damage.

Axial piston products parts evaluation

Scored piston - Series 51 shown



F101 706

Overspeed

Centrifugal forces on the piston, along with a loss of pressure balance on the piston ring and a degradation of the fluid viscosity result in wear on the piston skirt and piston bore.

The piston ring fracture is a result of wear on the lower skirt, reducing the support for the ring.

Piston overspeed - Series 51 shown



F101 707

Axial piston products parts evaluation

Scoring in block bores

Scoring in block bores is usually at the outer side of the bore. This is because centrifugal force is throwing the pistons out from center. If a piston or pistons are scored, the block bore will also be scored. The rough surface of the block bore is what scores the piston and removes enough material to let the ring come out of its groove.

Scoring may be caused by overspeeding or a twisted sync shaft.

Scoring in block bores - Series 51 shown



F101 708

Gear products parts evaluation

Shafts

Fretting corrosion

Shaft was destroyed because of inadequate lubrication of spline teeth. Subsequent build up of corrosion lead to fatigue cracking and failure.

Fretting corrosion



Fretting corrosion



P101709

Misalignment and fatigue

Shaft failure caused by misalignment and fatigue.

Shaft misalignment



Fatigue



P101759

Gear products parts evaluation

Fatigue lines

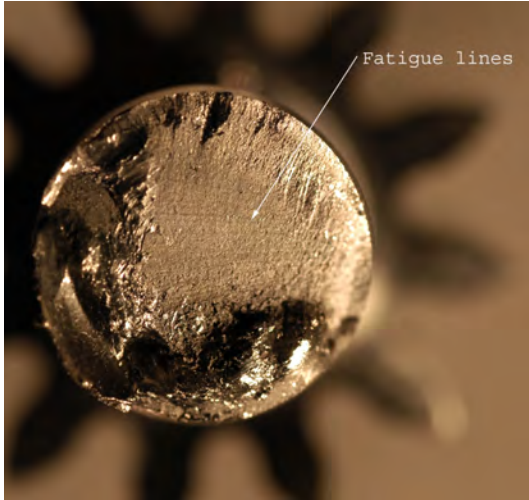

Failure caused by fatigue



P101763

Overload

Shaft failure caused by overload as a result of excessive pressure.

Cracking due to overload



Failure caused by overload

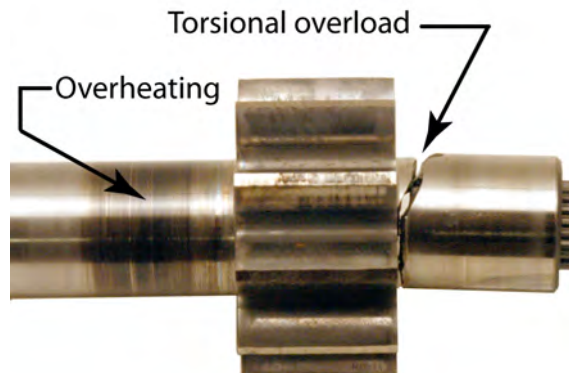

P101765

Gear products parts evaluation

Failure due to overload



Shaft failure caused by overload



P101767

Failure due to overload



Failure caused by overload



P101769

Gear products parts evaluation

Failure caused by overload



F101 771

Fatigue and wear

Failure caused by fatigue and wear. This type of failure may be a result of misalignment.

Failure due to wear



F101 775

Negative inlet pressure

Cavitation - adhesive wear

The front cover and bearing block are damaged due to aeration.

Gear products parts evaluation

Adhesive wear

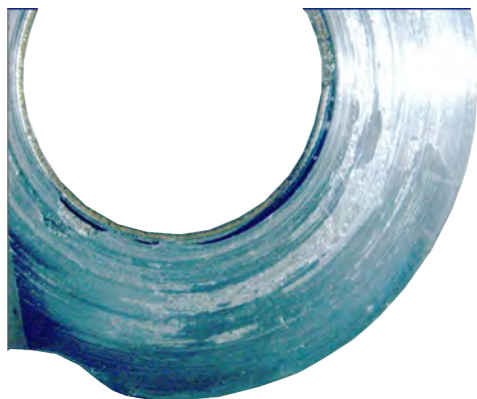

Cavitation

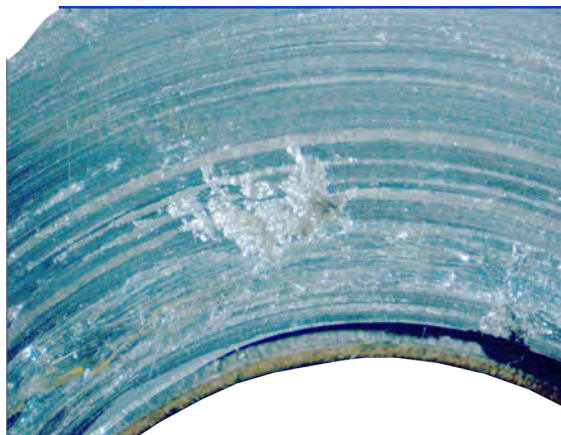

P101719

Normal cut-in appearance

Pump body showing normal cut-in

This photo shows a D pump body with normal cut-in wear marks.

Wear marks created during normal cut-in process



F101782

Aerated fluid

Aerated oil

Bearings show damage due to aerated fluid. Bearing block is shown with excessive wear caused by aerated oil.

Gear products parts evaluation

Bearing block



Bearing - areated oil

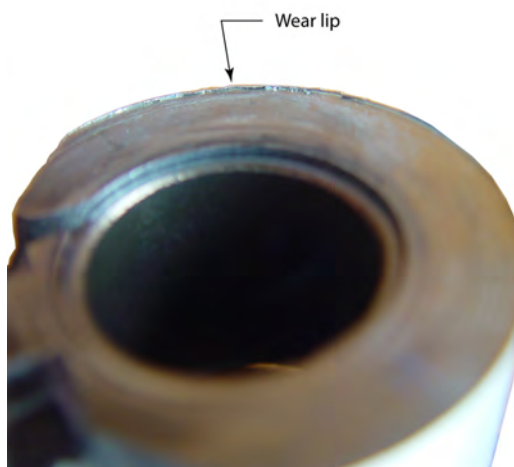

P101718

Front cover - Group 2 Aluminum body

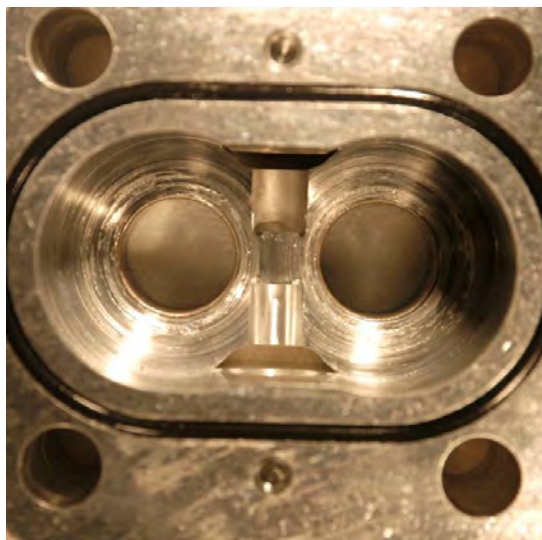

F101 717

Bronzing

Bronzing is caused by excessive radial load (external or overpressure) or low viscosity (hot oil) or poor finish on journal.

Gear products parts evaluation

Bronzing



F101 776

Side loading

Adhesive wear caused by side loading

Side loading caused excessive pressure and inadequate lubrication on idler bearing. Lack of lubrication caused the bearing to bind resulting in shaft failure.

Adhesive wear - D pump shown



Shaft overload

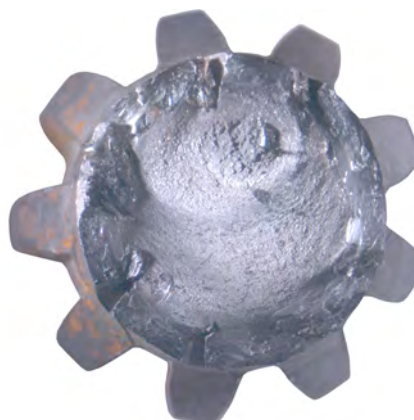

P101722

Gear products parts evaluation

Shaft overload



F101 757

Large particle contamination

Gear tooth failure

Pump failure due to large particle contamination. Object became lodged between the gear teeth causing tooth breakage when power was applied to the pump.

Large particle contamination - D pump



Large particle contamination - D pump

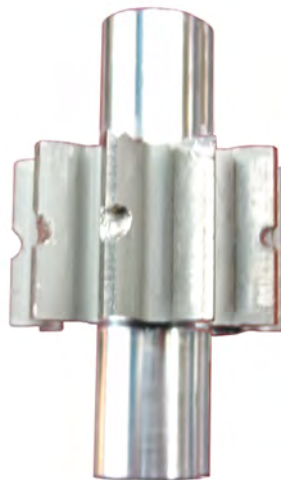

P101723

Gear products parts evaluation

Lack of lubricity

Failure caused by lack of lubricity

Lack of lubricity occurs when a pump runs out of fluid. The hydraulic fluid lubricates the shaft and gears when the pump is in operation. When a lack of lubricity occurs, the shaft and gears wear into the housing, covers and pressure plate. This wear also causes high temperature resulting in damaged seals and discolored components.

Damaged seal - D pump



Damaged pressure plate - D pump



P101779

Damaged rear cover - D pump



F101 781

Pressure spiking - overload

Cover/Housing failure caused by pressure spiking

Cracking shown is caused by pressure spiking. Over time, the cracks propogate completely through the housing causing catastrophic failure.

Gear products parts evaluation

Rear cover failure



Cracking due to pressure spikes

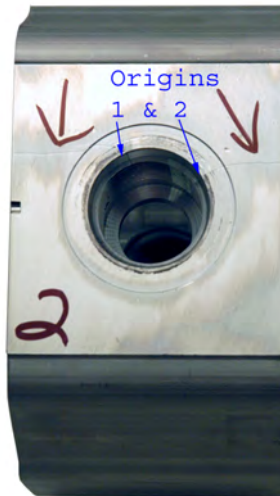

P101725

Fatigue lines



Cracking due to fatigue

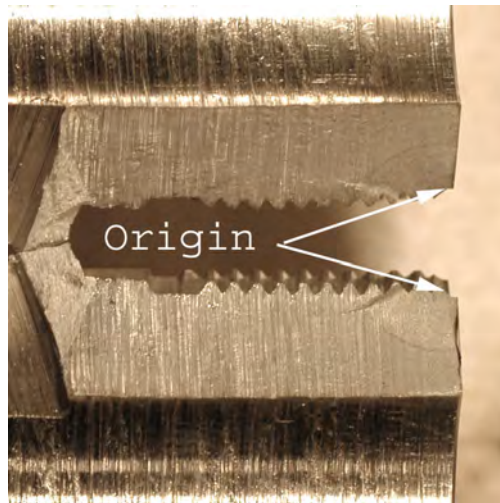

P101773

Over pressure

Failure caused by over pressure condition

Overpressure in pump caused lack of lubrication on shaft bearings. Lack of lubrication caused the shafts to wear into the bearings. Contamination from wear left marks in housing, shaft, and pressure plates.

Gear products parts evaluation

Wear marks on shaft



Blocked outlet port



P101728

Excessive discharge pressure

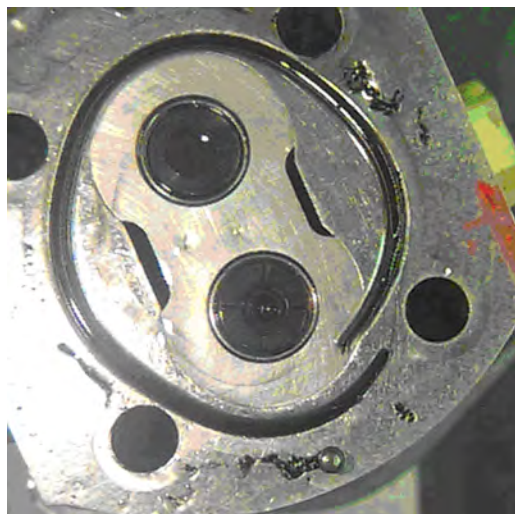

Excessive inlet pressure

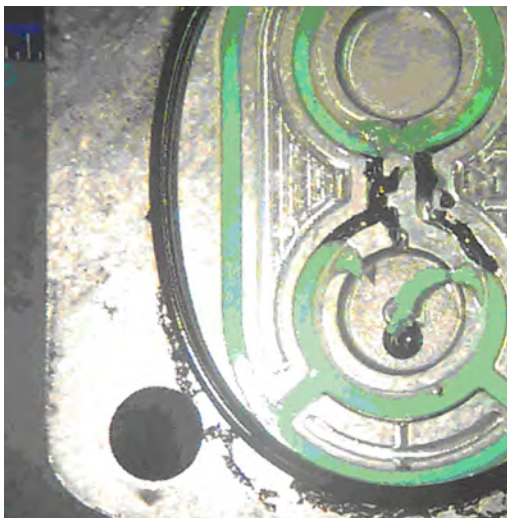

P101760

Gear products parts evaluation

Cracking due to overload

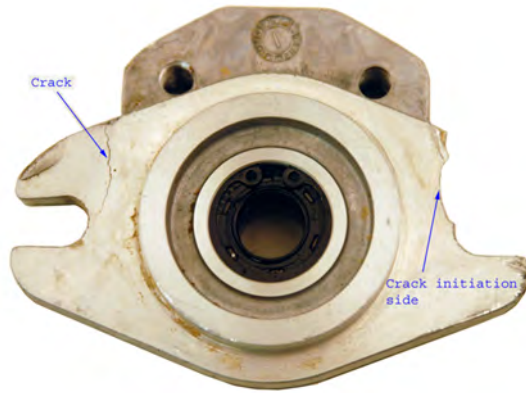

F101 772

Excessive cut-in

Failure caused by excessive cut-in

Wear marks in housing, shaft, and pressure plates caused by excessive cut-in.

Wear marks on pressure plates



F101 729

Over temperature

Failure caused by excessive temperature

Excessive operating temperature can cause deterioration of seals. This pressure seal is eroded due to excessive temperature.

Gear products parts evaluation

Damaged pressure seal



F101 761



Products we offer:

- Bent Axis Motors
- Closed Circuit Axial Piston Pumps and Motors
- Displays
- Electrohydraulic Power Steering
- Electrohydraulics
- Hydraulic Power Steering
- Integrated Systems
- Joysticks and Control Handles
- Microcontrollers and Software
- Open Circuit Axial Piston Pumps
- Orbital Motors
- PLUS+1® GUIDE
- Proportional Valves
- Sensors
- Steering
- Transit Mixer Drives

Danfoss Power Solutions is a global manufacturer and supplier of high-quality hydraulic and electronic components. We specialize in providing state-of-the-art technology and solutions that excel in the harsh operating conditions of the mobile off-highway market. Building on our extensive applications expertise, we work closely with our customers to ensure exceptional performance for a broad range of off-highway vehicles.

We help OEMs around the world speed up system development, reduce costs and bring vehicles to market faster.

Danfoss – Your Strongest Partner in Mobile Hydraulics.

Go to www.powersolutions.danfoss.com for further product information.

Wherever off-highway vehicles are at work, so is Danfoss. We offer expert worldwide support for our customers, ensuring the best possible solutions for outstanding performance. And with an extensive network of Global Service Partners, we also provide comprehensive global service for all of our components.

Please contact the Danfoss Power Solution representative nearest you.

Comatrol

www.comatrol.com

Schwarzmueller-Inverter

www.schwarzmueller-inverter.com

Turolla

www.turollaocg.com

Valmova

www.valmova.com

Hydro-Gear

www.hydro-gear.com

Daikin-Sauer-Danfoss

www.daikin-sauer-danfoss.com

Local address:

Danfoss Power Solutions US Company

2800 East 13th Street
Ames, IA 50010, USA
Phone: +1 515 239 6000

Danfoss Power Solutions GmbH & Co. OHG

Krokamp 35
D-24539 Neumünster, Germany
Phone: +49 4321 871 0

Danfoss Power Solutions ApS

Nordborgvej 81
DK-6430 Nordborg, Denmark
Phone: +45 7488 2222

Danfoss Power Solutions (Shanghai) Co., Ltd.

Building #22, No. 1000 Jin Hai Rd
Jin Qiao, Pudong New District
Shanghai, China 201206
Phone: +86 21 3418 5200

Danfoss can accept no responsibility for possible errors in catalogues, brochures and other printed material. Danfoss reserves the right to alter its products without notice. This also applies to products already on order provided that such alterations can be made without changes being necessary in specifications already agreed. All trademarks in this material are property of the respective companies. Danfoss and the Danfoss logotype are trademarks of Danfoss A/S. All rights reserved.